

7 - Wasserleitungen verbinden/ install water hose

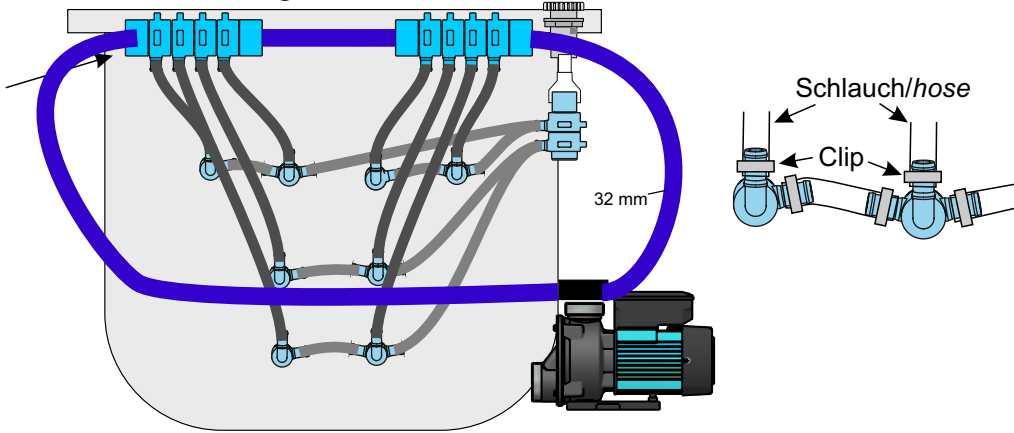

8 - Ansaugung installieren und verkleben/ install suction and glue

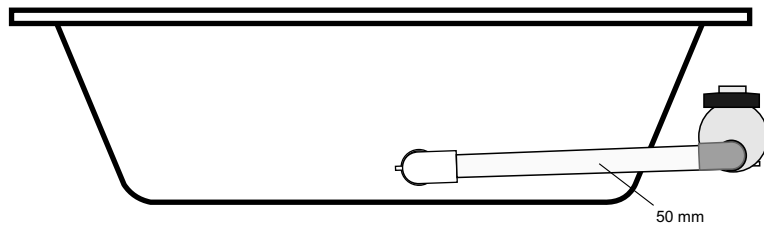

Nach dem Kleben trocknen lassen/ need to dry after gluing

9 - Taster installieren und anschließen/ install pushbutton and connect

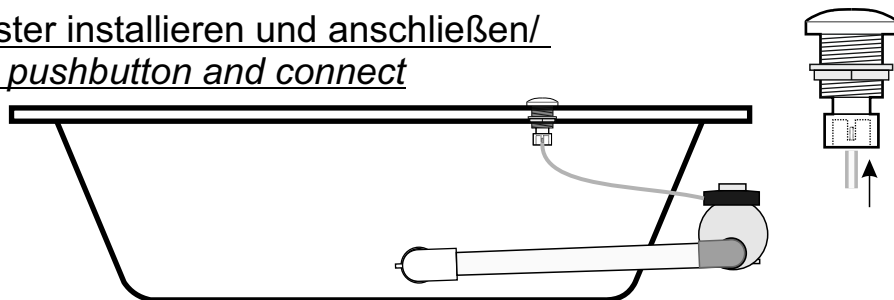

Nach dem Kleben trocknen lassen/ need to dry after gluing

Testen Sie Ihr Whirlpoolsystem / Test your Whirlpoolsystem!

Einbauanleitung

Whirlpool Microjets F18 / WS10

Installation manual

Whirlpool hydromassage F18 / WS10

Lesen Sie bitte **vor** der Installation diese Einbauanleitung sorgfältig durch und bewahren Sie diese auf!

ENGLISH: Please read this manual before you start the installation carefully and keep it for reference!



Wuschik Wellness - Leidersbach - Germany

www.wuschik.com

1 - Planen & Anzeichnen / *plan & mark*

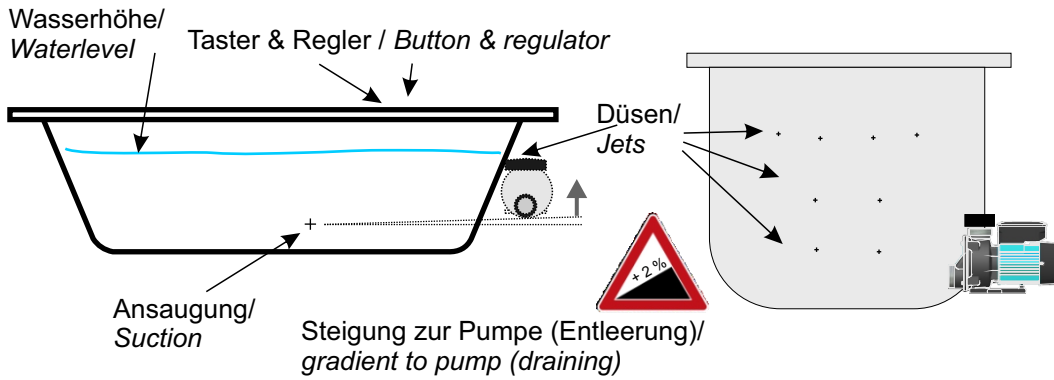

4 - Luftregler installieren/ *Install air regulator*

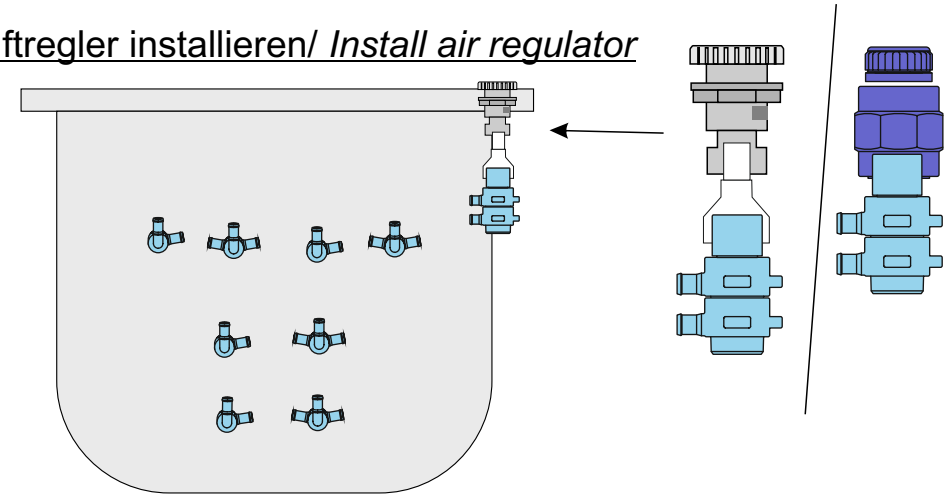

2 - Bohren & Reinigen / *Drill & Clean*

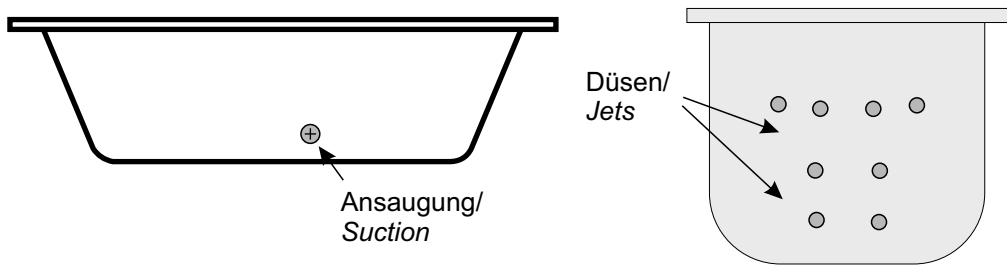

5 - Luftleitungen verbinden/ *Install air hose*

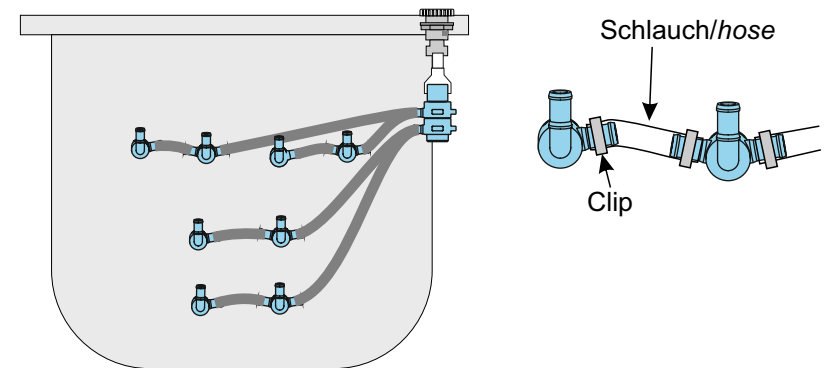

3 - Düsen installieren/ *Install jets*

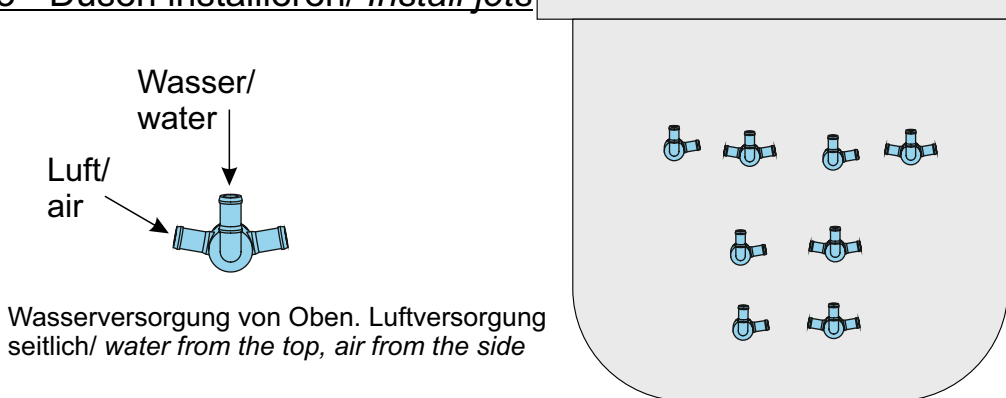

6 - Pumpe + Verteiler WS / *pump + manifold water*

